

Varenummer: 0106057
 Beskrivelse: Seeger låsering JV 40

Mål

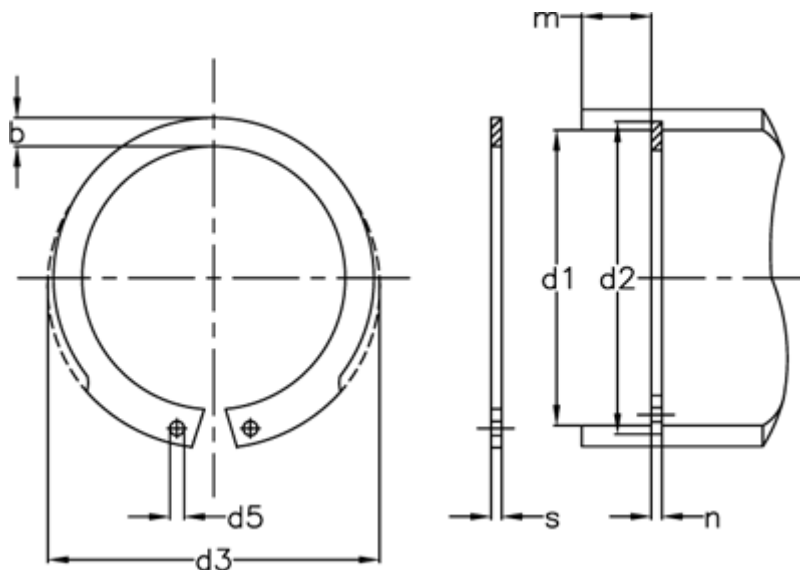

AN mm ²	= 81	FRg kN	= 8.4	Tang	= ZGJ-2
b	= 4.2	FR kN	= 45.5	tol	= -0.06
Betegnelse	= JV 40	g	= 2.0	tol	= +0,90-0,39
d1	= 40	K kN-mm	= 82.5	tol	= +0,25
d2	= 42.5	m min	= 1.85	tol	= 0.2
d3	= 43.5	Nominel træk	= 3.8	vægt kg/1000	= 4.75
d5 min	= 2.0	s	= 1.75		
FN kN	= 13.50	t	= 1.25		